

B-301

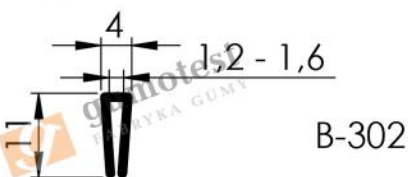

B-302

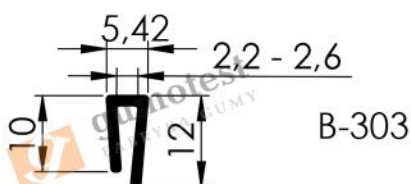

B-303

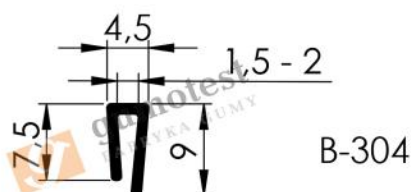

B-304



B-305

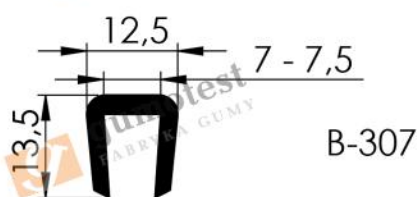

B-307

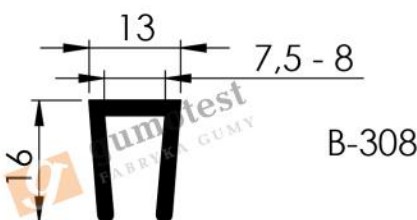

B-308

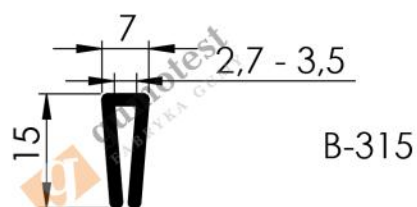

B-315

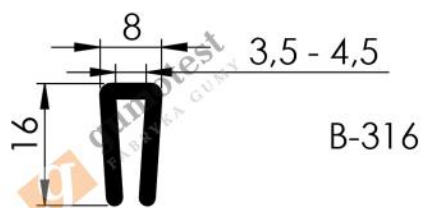

B-316

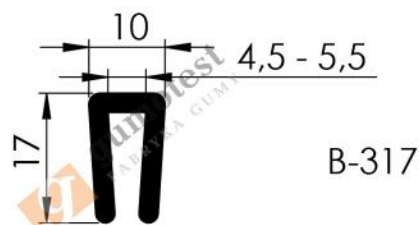

B-317

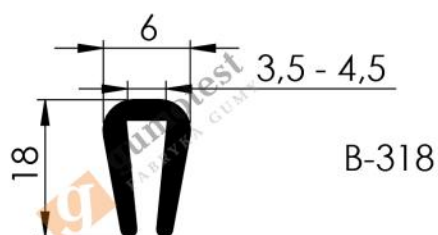

B-318

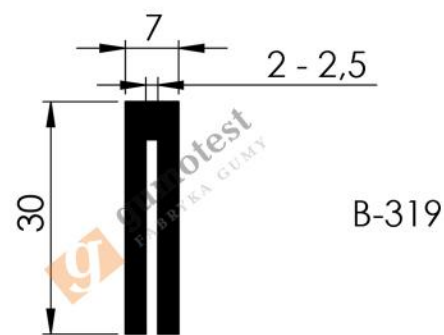

B-319

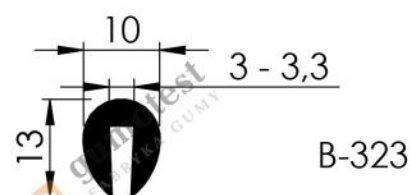

B-323

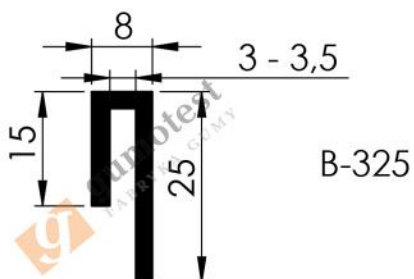

B-325

gumotest
FABRYKA GUMY

GUMOTEST Zbigniew Kawatek

Mazańcowice 57

PL 43-391 Mazańcowice

Phone: +48 33 815-62-19

Website: www.gumotest.pl

E-mail: biuro@gumotest.pl

Profile Krawędziowe 1/2

SKALA

1:1

NUMER RYSUNKU

v1-02-01

MATERIAŁ

EPDM, NBR, PVC

FORMAT

A4

DATA

21.04.2021

VTR

1049028.79

